

# Dell Vostro 3901 Owner's Manual

Regulatory Model: D17M  
Regulatory Type: D17M002



# Notes, Cautions, and Warnings

 **NOTE:** A NOTE indicates important information that helps you make better use of your computer.

 **CAUTION:** A CAUTION indicates either potential damage to hardware or loss of data and tells you how to avoid the problem.

 **WARNING:** A WARNING indicates a potential for property damage, personal injury, or death.

**Copyright © 2014 Dell Inc. All rights reserved.** This product is protected by U.S. and international copyright and intellectual property laws. Dell™ and the Dell logo are trademarks of Dell Inc. in the United States and/or other jurisdictions. All other marks and names mentioned herein may be trademarks of their respective companies.

2014 - 07

Rev. A01

# Contents

<b>1 Working on Your Computer.....</b>	<b>5</b>
Before Working Inside Your Computer.....	5
Turning Off Your Computer.....	6
After Working Inside Your Computer.....	7
<b>2 Removing and Installing Components.....</b>	<b>8</b>
Recommended Tools.....	8
System Overview.....	8
Inside view .....	8
Removing the Cover.....	9
Installing the Cover.....	9
Removing the Bezel.....	9
Installing the Bezel.....	10
Removing the Coin-Cell Battery.....	10
Installing the Coin-Cell Battery.....	11
Removing the Hard Drive.....	11
Installing the Hard Drive.....	12
Removing the Optical Drive.....	12
Installing the Optical Drive.....	12
Removing the Card Reader.....	13
Installing the Card Reader.....	13
Removing the Memory.....	13
Installing the Memory.....	14
Removing the Heatsink.....	14
Installing the Heatsink.....	15
Removing the Processor.....	15
Installing the Processor.....	16
Removing the Expansion Card(s).....	16
Installing the Expansion Card(s).....	17
Removing the Power Supply Unit (PSU).....	17
Installing the Power Supply Unit (PSU).....	18
Removing the Power Switch.....	18
Installing the Power Switch.....	19
Removing the Input/Output (I/O) Panel.....	19
Installing the Input/Output (I/O) Panel.....	20
Removing the Wireless Device.....	21
Installing the Wireless Device.....	21
Removing the System Fan.....	22

Installing the System Fan.....	22
Removing the System Board.....	22
Installing the System Board.....	23
System Board Components.....	23
<b>3 Troubleshooting Your Computer.....</b>	<b>25</b>
Diagnostic Power LED Codes.....	25
Diagnostic Error Messages.....	26
System Error Messages.....	30
<b>4 System Setup Options.....</b>	<b>31</b>
Main.....	31
Advanced.....	32
Boot.....	32
Power.....	33
Security.....	33
Exit.....	33
System Setup Overview.....	33
Enter System Setup.....	34
<b>5 Specifications.....</b>	<b>35</b>
<b>6 Contacting Dell.....</b>	<b>38</b>

# Working on Your Computer

## Before Working Inside Your Computer

Use the following safety guidelines to help protect your computer from potential damage and to help to ensure your personal safety. Unless otherwise noted, each procedure included in this document assumes that the following conditions exist:

- You have read the safety information that shipped with your computer.
- A component can be replaced or--if purchased separately--installed by performing the removal procedure in reverse order.

 **WARNING:** Disconnect all power sources before opening the computer cover or panels. After you finish working inside the computer, replace all covers, panels, and screws before connecting to the power source.

 **WARNING:** Before working inside your computer, read the safety information that shipped with your computer. For additional safety best practices information, see the Regulatory Compliance Homepage at [www.dell.com/regulatory\\_compliance](http://www.dell.com/regulatory_compliance)

 **CAUTION:** Many repairs may only be done by a certified service technician. You should only perform troubleshooting and simple repairs as authorized in your product documentation, or as directed by the online or telephone service and support team. Damage due to servicing that is not authorized by Dell is not covered by your warranty. Read and follow the safety instructions that came with the product.

 **CAUTION:** To avoid electrostatic discharge, ground yourself by using a wrist grounding strap or by periodically touching an unpainted metal surface, such as a connector on the back of the computer.

 **CAUTION:** Handle components and cards with care. Do not touch the components or contacts on a card. Hold a card by its edges or by its metal mounting bracket. Hold a component such as a processor by its edges, not by its pins.

 **CAUTION:** When you disconnect a cable, pull on its connector or on its pull-tab, not on the cable itself. Some cables have connectors with locking tabs; if you are disconnecting this type of cable, press in on the locking tabs before you disconnect the cable. As you pull connectors apart, keep them evenly aligned to avoid bending any connector pins. Also, before you connect a cable, ensure that both connectors are correctly oriented and aligned.

 **NOTE:** The color of your computer and certain components may appear differently than shown in this document.

To avoid damaging your computer, perform the following steps before you begin working inside the computer.

1. Ensure that your work surface is flat and clean to prevent the computer cover from being scratched.
2. Turn off your computer (see Turning Off Your Computer).





**⚠ CAUTION: To disconnect a network cable, first unplug the cable from your computer and then unplug the cable from the network device.**

3. Disconnect all network cables from the computer.
4. Disconnect your computer and all attached devices from their electrical outlets.
5. Press and hold the power button while the computer is unplugged to ground the system board.
6. Remove the cover.

**⚠ CAUTION: Before touching anything inside your computer, ground yourself by touching an unpainted metal surface, such as the metal at the back of the computer. While you work, periodically touch an unpainted metal surface to dissipate static electricity, which could harm internal components.**

## Turning Off Your Computer

**⚠ CAUTION: To avoid losing data, save and close all open files and exit all open programs before you turn off your computer.**

1. Shut down the operating system:
  - In Windows 8:
    - Using a touch-enabled device:
      - a. Swipe in from the right edge of the screen, opening the Charms menu and select **Settings**.
      - b. Select the  and then select **Shut down**
    - Using a mouse:
      - a. Point to upper-right corner of the screen and click **Settings**.
      - b. Click the  and select **Shut down**.
  - In Windows 7:
    1. Click **Start** .
    2. Click **Shut Down**.or
    1. Click **Start** .
    2. Click the arrow in the lower-right corner of the **Start** menu as shown below, and then click **Shut Down..** 
2. Ensure that the computer and all attached devices are turned off. If your computer and attached devices did not automatically turn off when you shut down your operating system, press and hold the power button for about 6 seconds to turn them off.

## After Working Inside Your Computer

After you complete any replacement procedure, ensure you connect any external devices, cards, and cables before turning on your computer.

1. Replace the cover.



**CAUTION: To connect a network cable, first plug the cable into the network device and then plug it into the computer.**

2. Connect any telephone or network cables to your computer.
3. Connect your computer and all attached devices to their electrical outlets.
4. Turn on your computer.
5. If required, verify that the computer works correctly by running the Dell Diagnostics.

# Removing and Installing Components

This section provides detailed information on how to remove or install the components from your computer.

## Recommended Tools

The procedures in this document may require the following tools:

- Small flat-blade screwdriver
- Phillips screwdriver
- Small plastic scribe

## System Overview

### Inside view

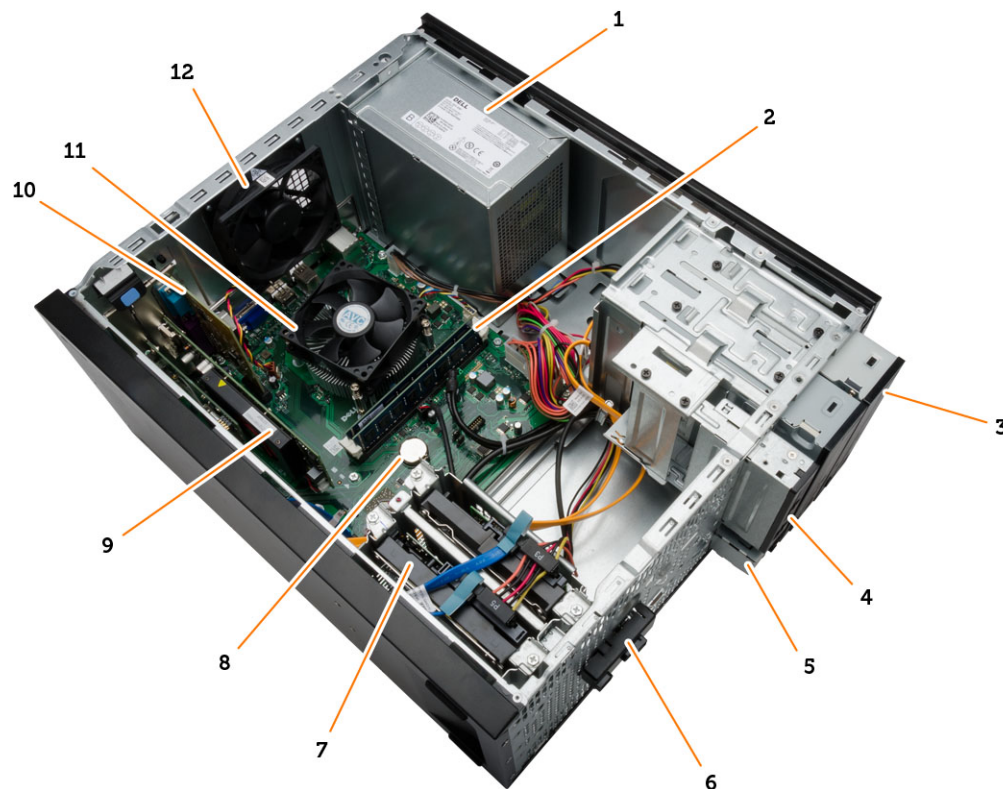

1. Power Supply Unit (PSU)

2. memory module

- |                  |                       |
|------------------|-----------------------|
| 3. optical drive | 4. card reader        |
| 5. I/O board     | 6. power-switch board |
| 7. hard drive    | 8. coin-cell battery  |
| 9. VGA card      | 10. expansion card    |
| 11. heatsink     | 12. system fan        |

## Removing the Cover

1. Follow the procedures in *Before Working Inside Your Computer*.
2. Follow the steps to remove the cover:
  - a. Remove the screws that secure the cover to the computer.
  - b. Slide the computer cover towards the back of the computer [1].
  - c. Lift and remove the cover from the computer [2].

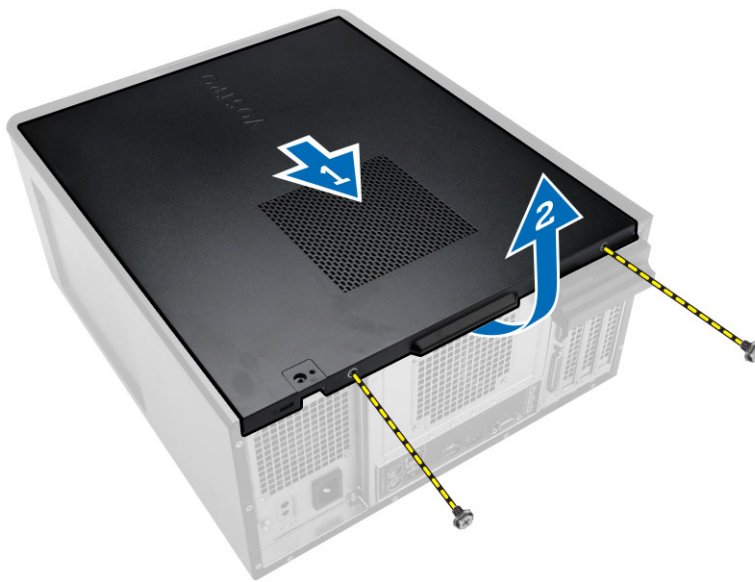

## Installing the Cover

1. Place the cover on the chassis.
2. Replace the screws to secure the cover to the computer.
3. Follow the procedures in *After Working Inside Your Computer*.

## Removing the Bezel

1. Follow the procedures in *Before Working Inside Your Computer*.
2. Remove the cover.
3. Follow the steps to remove the bezel:
  - a. Pry the front panel retention clips away from the chassis.
  - b. Release the hooks on the opposite edge of the bezel from the chassis.
  - c. Remove the bezel from the computer.

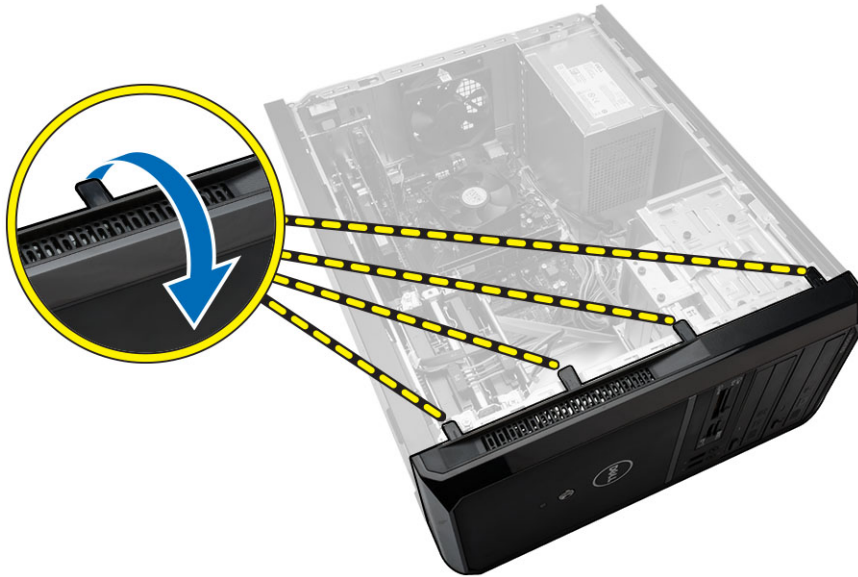

## Installing the Bezel

1. Place the hooks on the notches in the computer.
2. Rotate the front bezel towards the computer.
3. Press the front bezel until the tabs snap in to place.
4. Install the cover.
5. Follow the procedures in *After Working Inside Your Computer*.

## Removing the Coin-Cell Battery

1. Follow the procedures in *Before Working Inside Your Computer*.
2. Remove the cover.
3. Push the coin-cell release latch and pull the coin-cell battery to remove it from the computer.

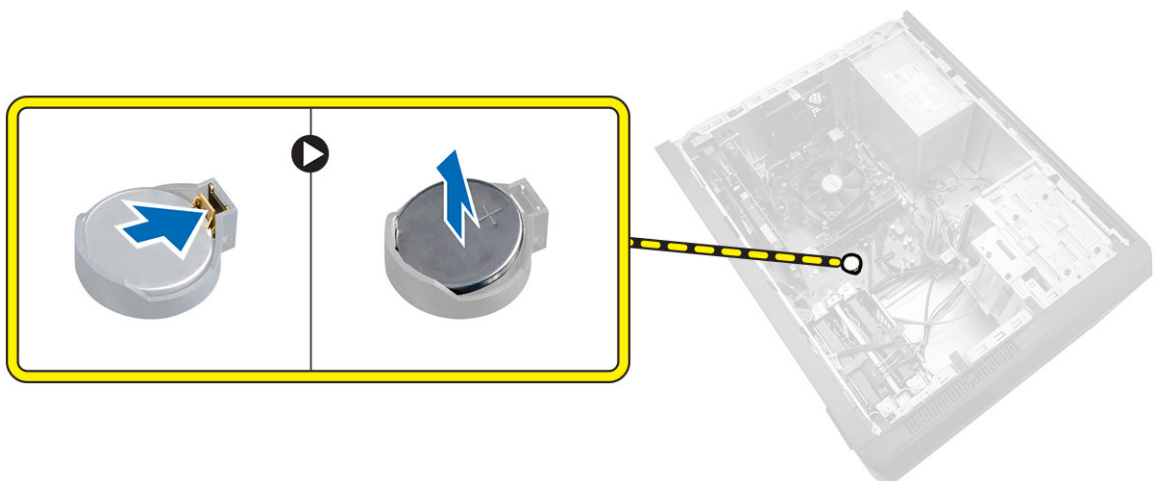

## Installing the Coin-Cell Battery

1. Place the coin-cell battery on the system board until it snaps in place.
2. Install the cover.
3. Follow the procedures in *After Working Inside Your Computer*.

## Removing the Hard Drive

1. Follow the procedures in *Before Working Inside Your Computer*.
2. Remove the:
  - cover
  - bezel
3. Follow the steps to remove the SATA cable and the power cable:
  - a. Disconnect the SATA cable and power cable from the hard drive [1] [2].
  - b. Remove the screws that secure the hard-drive bracket [3] and lift it upwards to remove it from the computer [4].

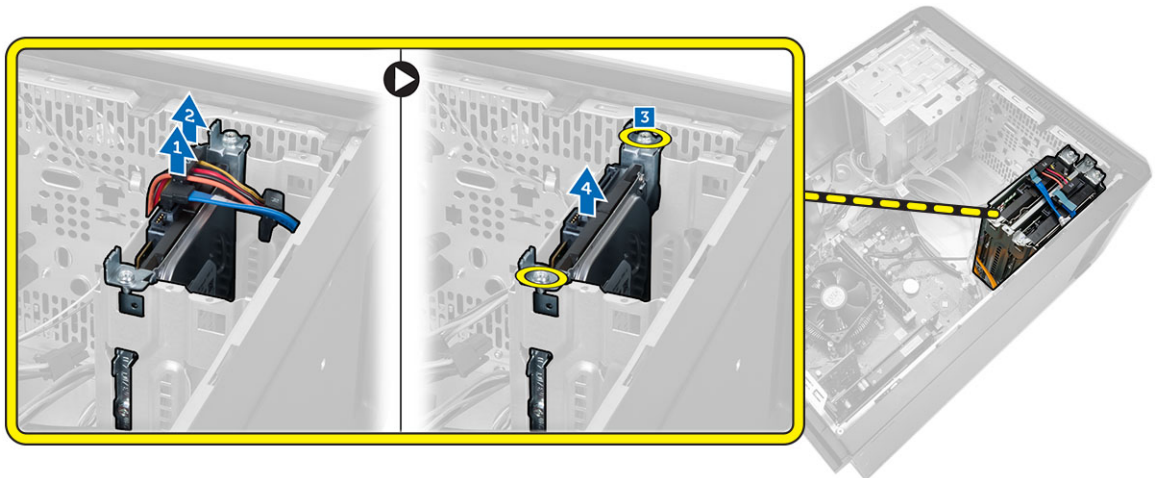

4. Follow the steps to remove the hard-drive bracket.
  - a. Remove the screws that secure the hard-drive bracket.
  - b. Lift and remove the hard drive from the hard-drive bracket.

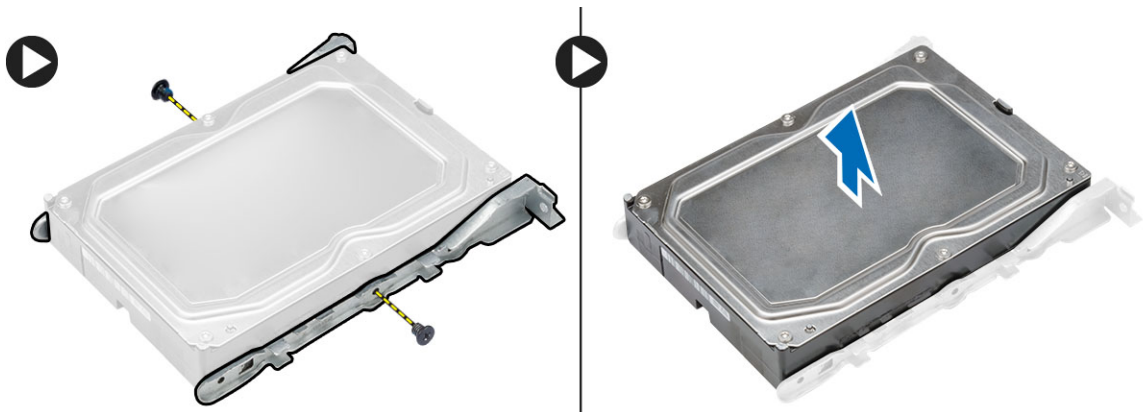

## Installing the Hard Drive

1. Replace the hard drive into the hard-drive bracket.
2. Install the screws that secure the hard-drive bracket.
3. Install the hard drive into its slot in the computer.
4. Install the screws that secure the hard drive to the computer.
5. Connect the SATA cable and the power cable to the hard drive.
6. Install the:
  - bezel
  - cover
7. Follow the procedures in *After Working Inside Your Computer*.

## Removing the Optical Drive

1. Follow the procedures in *Before Working Inside Your Computer*.
2. Remove the:
  - cover
  - bezel
3. Follow the steps to remove the optical drive:
  - a. Disconnect the data cable [1] and power cable [2] from the optical drive.
  - b. Remove the screws that secure the optical drive and then push the optical drive towards the front of the computer.
  - c. Remove the optical drive from the computer [3].

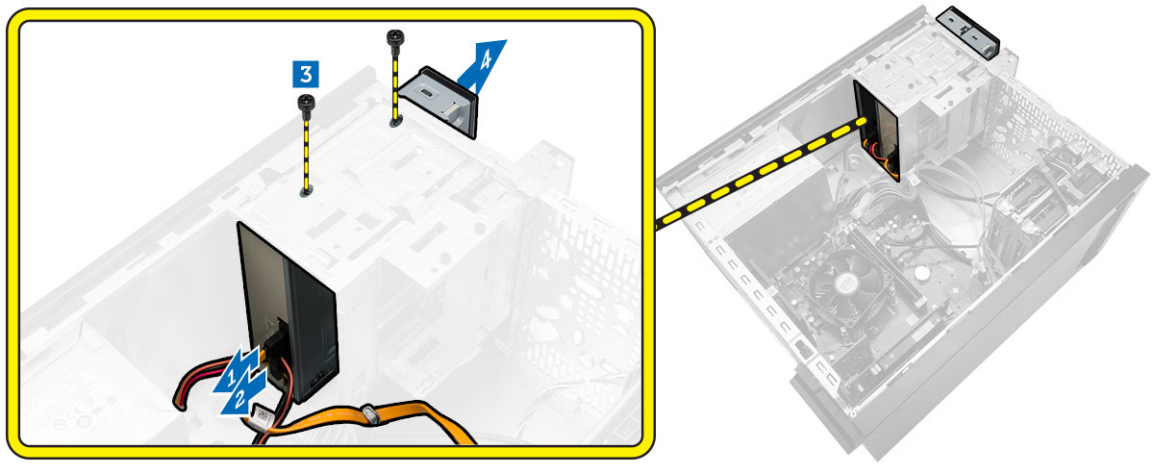

## Installing the Optical Drive

1. Push the optical drive into the computer until it snaps into place.
2. Install the screws that secure the optical drive.
3. Connect the data cable and power cable to the optical drive.
4. Install the:

- bezel
  - cover
5. Follow the procedures in *After Working Inside Your Computer*.

## Removing the Card Reader

1. Follow the procedures in *Before Working Inside Your Computer*.
2. Remove the:
  - cover
  - bezel
3.
  - a. Disconnect the card reader power cable from the system board.
  - b. Un-thread the power cable from the metal clip.
  - c. Remove the screws that secure the card reader to the chassis.
  - d. Push the card reader towards the front of the computer.
  - e. Remove the card reader from the computer.

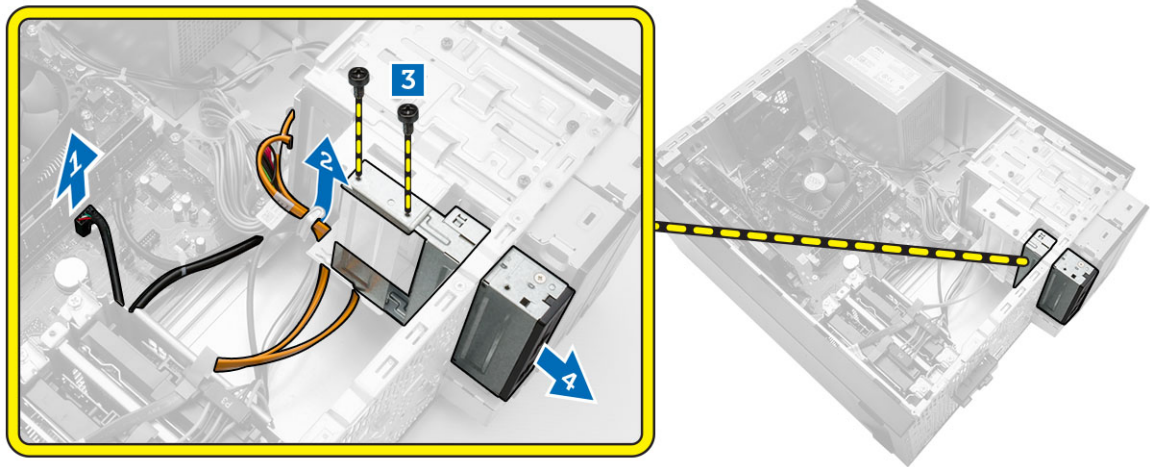

## Installing the Card Reader

1. Push the card reader into the computer until it snaps into place.
2. Install the screws that secure the card reader to the chassis.
3. Thread the card reader power cable through the metal clip.
4. Connect the card reader power cable to the system board.
5. Install the:
  - bezel
  - cover
6. Follow the procedures in *After Working Inside Your Computer*.

## Removing the Memory

1. Follow the procedures in *Before Working Inside Your Computer*.
2. Remove the cover.

3. Press down on the memory-retaining tabs on each side of the memory modules and lift the memory module upwards to remove it from the computer.

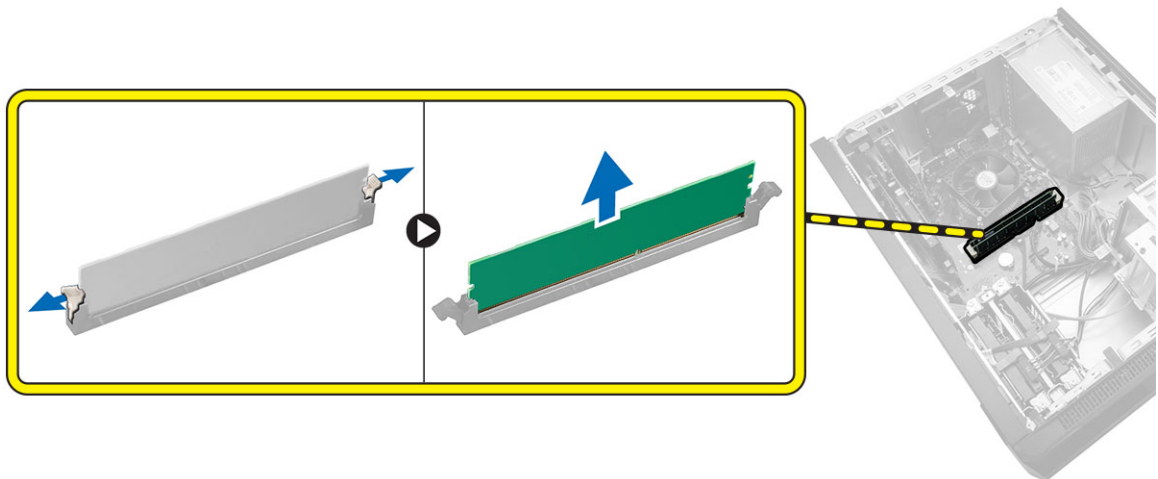

## Installing the Memory

1. Align the notch on the memory-card with the tab in the system-board connector.
2. Insert the memory module into the memory socket.
3. Press down on the memory module until the securing clips secure the memory in place.
4. Install the cover.
5. Follow the procedures in *After Working Inside Your Computer*.

## Removing the Heatsink

1. Follow the procedures in *Before Working Inside Your Computer*.
2. Remove the cover.
3. Follow the steps to remove the processor heatsink:
  - a. Disconnect the heatsink cable from the system board.
  - b. Loosen the captive screws that secure the heatsink to the system board.
  - c. Lift the heatsink upward and remove it from the computer.

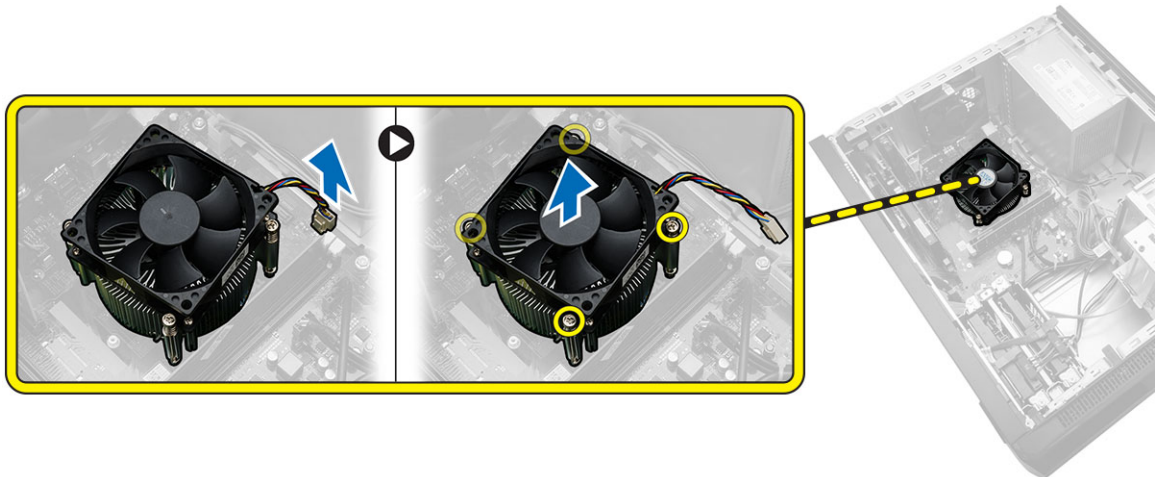

## Installing the Heatsink

1. Place the heatsink on the processor.
2. Tighten the captive screws that secure the heatsink to the system board.
3. Connect the heatsink cable to the system board.
4. Install the cover.
5. Follow the procedures in *After Working Inside Your Computer*.

## Removing the Processor

1. Follow the procedures in *Before Working Inside Your Computer*.
2. Remove the:
  - cover
  - heatsink
3. Push the processor release lever down and then press it outward to release it from the retention hook that secures it.
4. Raise the processor cover and lift the processor to remove it from the computer.



## Installing the Processor

1. Install the processor into the socket.
2. Press down the processor cover to secure it inside the socket.
3. Push the release lever down and then press it inward to hold the retention hook that secures it.
4. Install the:
  - heatsink
  - cover
5. Follow the procedures in *After Working Inside Your Computer*.

## Removing the Expansion Card(s)

1. Follow the procedures in *Before Working Inside Your Computer*.
2. Remove the cover.
3. Follow the steps to remove the expansion card:
  - a. Press the blue tab and slide down the release lever that secures the expansion card.
  - b. Press on the retaining tab to release the expansion card from its connector.
  - c. Lift the expansion card up out of its connector and remove it from the computer.
  - d. Repeat the same sequence of steps to remove any additional expansion card installed.

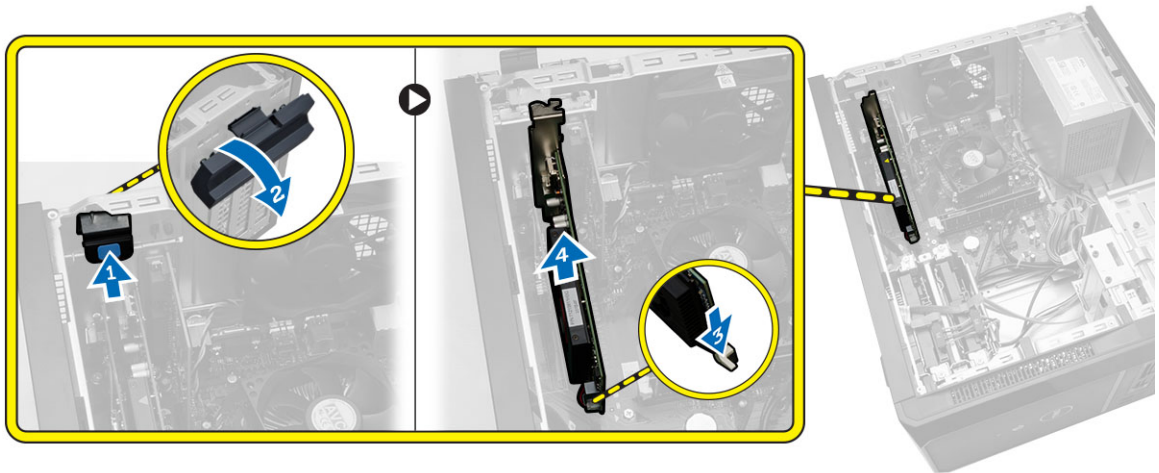

## Installing the Expansion Card(s)

1. Place the expansion card in its connector.
2. Secure the expansion card by pushing the card-retention latch until it snaps into place.
3. Repeat the steps to install any additional expansion cards.
4. Install the cover.
5. Follow the procedures in *After Working Inside Your Computer*.

## Removing the Power Supply Unit (PSU)

1. Follow the procedures in *Before Working Inside Your Computer*.
2. Remove the cover.
3. Disconnect the following power supply cables from the system board by pressing on the retention latch and lifting it upwards.
  - system board power cable [1]
  - system fan power cable [2]

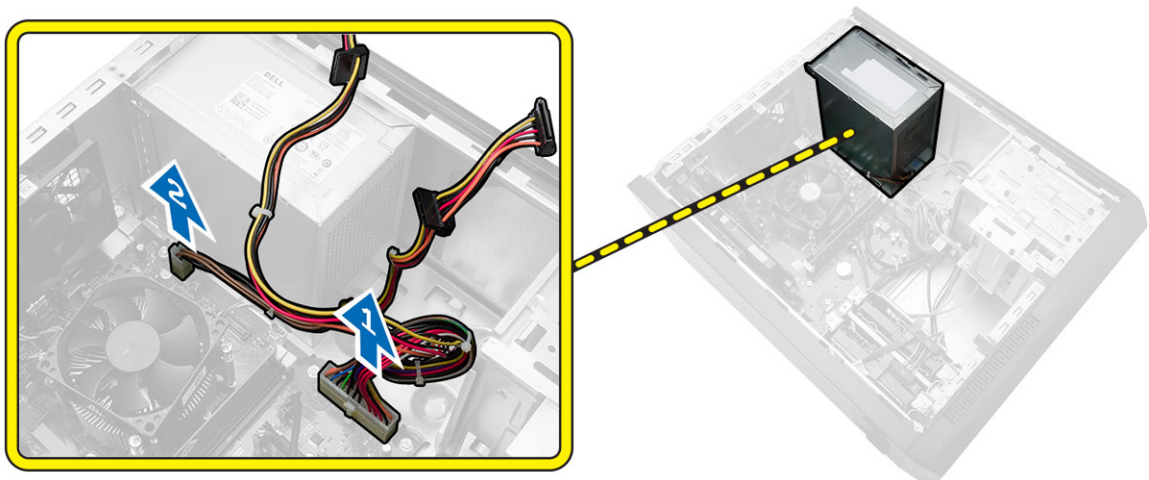

4. Follow the steps below to remove the power supply unit:
  - a. Remove the screws that secure the power supply to the computer.
  - b. Push-in on the blue release tab beside the power supply [1].
  - c. Slide the power supply unit towards the back and remove it from the computer.

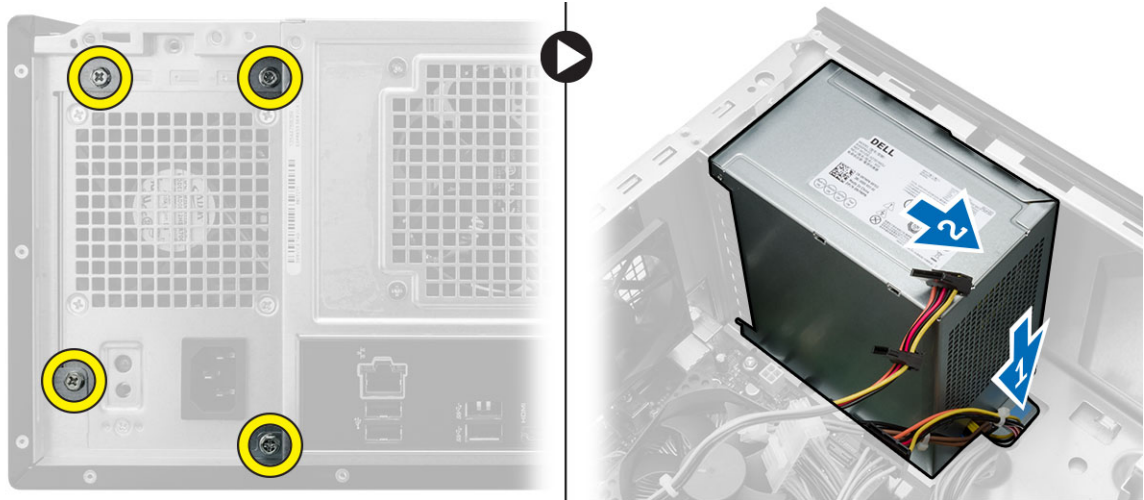

## Installing the Power Supply Unit (PSU)

1. Slide the PSU towards the back of the computer until it snaps into place.
2. Replace the screws to secure the power supply until to the computer.
3. Connect the power cables to the system board.
4. Install the cover.
5. Follow the procedures in *After Working Inside Your Computer*.

## Removing the Power Switch

1. Follow the procedures in *Before Working Inside Your Computer*.
2. Remove the:
  - cover
  - bezel
3. Follow the steps to remove the power switch:
  - a. Disconnect the power-switch cable from the system board [1].
  - b. Un-thread the power-switch cable from the metal retention clip [2].
  - c. Remove the power button by pressing on the two latches and pulling it out from the slot [3,4].

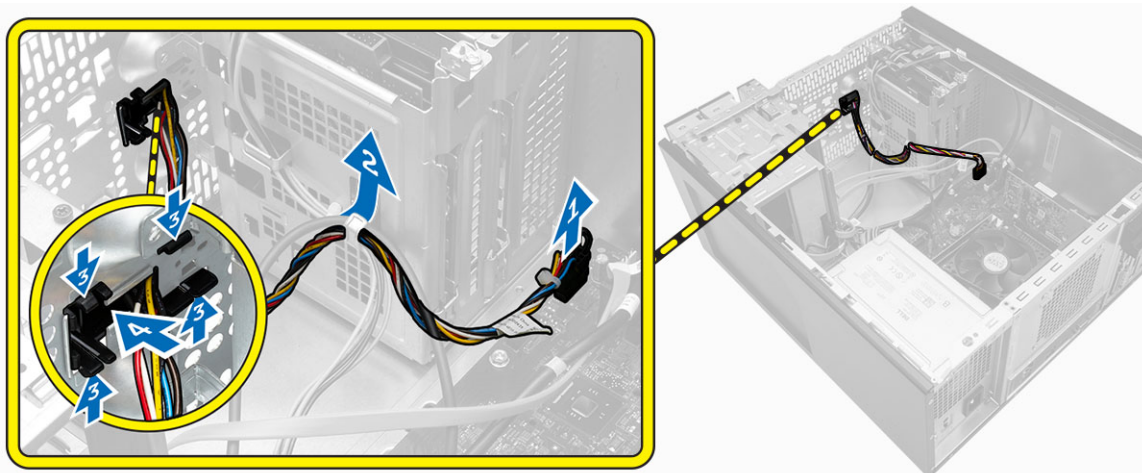

## Installing the Power Switch

1. Insert the power-switch cable through the front of the computer.
2. Push the power button into its slot and press it in, until it snaps into place.
3. Route the power-switch cable through the metal clip.
4. Connect the power-switch cable to the system board.
5. Install the:
  - bezel
  - cover
6. Follow the procedures in *After Working Inside Your Computer*.

## Removing the Input/Output (I/O) Panel

1. Follow the procedures in *Before Working Inside Your Computer*.
2. Remove the:
  - cover
  - bezel
3. Follow the steps to remove the I/O panel cables:
  - a. Disconnect the I/O panel and FlyWire cables from the system board [1, 3].
  - b. Un-thread the cables from the metal retention clips [2, 4].

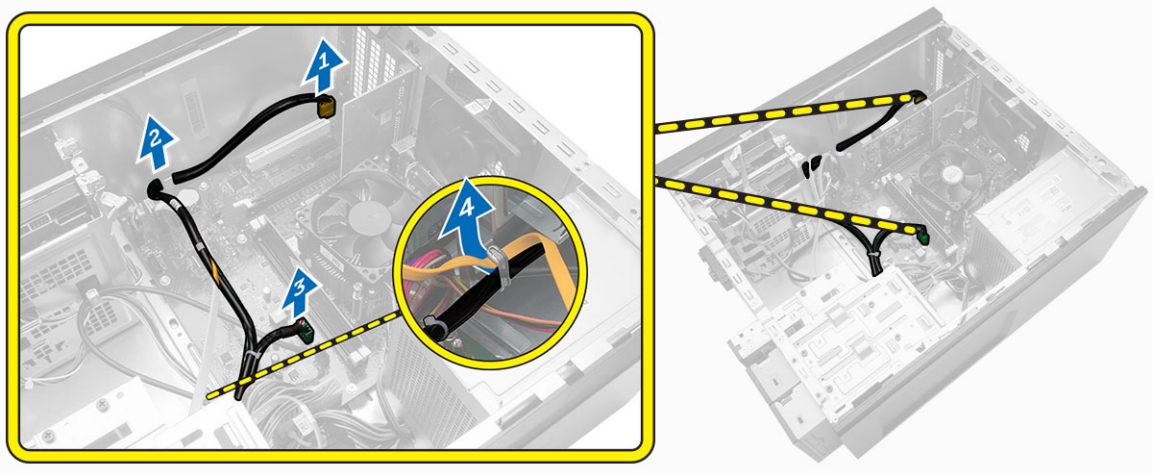

4. Follow the steps to remove the I/O panel:
  - a. Remove the screw that secures the I/O panel to the computer.
  - b. Slide the I/O panel outwards and remove it from the computer.

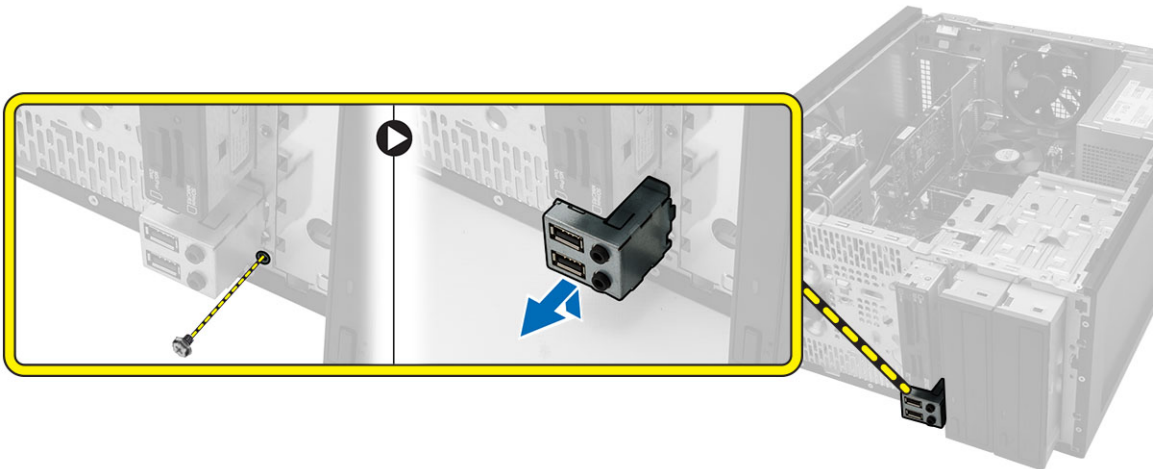

## Installing the Input/Output (I/O) Panel

1. Slide the I/O panel into its slot on the computer.
2. Replace the screw that secures the I/O panel.
3. Route the cables through the metal clips.
4. Connect the I/O panel and FlyWire cables to the system board.
5. Install the:
  - bezel
  - cover
6. Follow the procedures in *After Working Inside Your Computer*.

## Removing the Wireless Device

1. Follow the procedures in *Before Working Inside Your Computer*.
2. Follow the procedures to remove the wireless device from the computer:
  - a. Remove the screws that secure the wireless-device cable from the computer.
  - b. Disconnect the wireless-device cable from its connector and remove it from the computer.

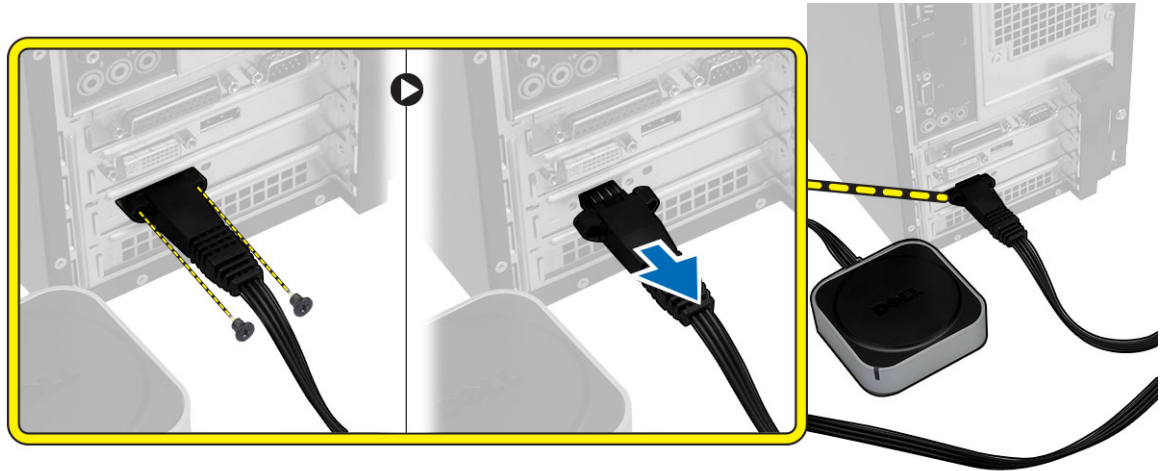

3. Press the blue tab [1] and slide down the release-lever that secures the wireless LAN card [2].
4. Pull the wireless LAN card to remove from the computer [3].

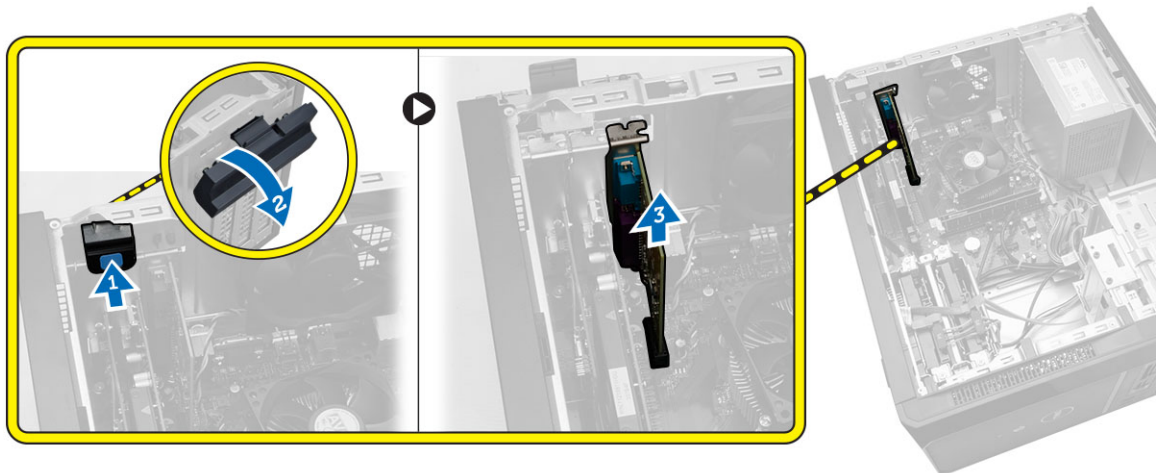

## Installing the Wireless Device

1. Install the wireless LAN card to its connector on the system board.
2. Install the release-lever to secure the wireless LAN card.
3. Connect the wireless-device cable to its connector on the computer.
4. Tighten the screws to secure the wireless-device cable to the computer.
5. Follow the procedures in *After Working Inside Your Computer*.

## Removing the System Fan

1. Follow the procedures in *Before Working Inside Your Computer*.
2. Remove the cover.
3. Follow the steps to remove the system fan:
  - a. Disconnect the fan cable from the system board.
  - b. Remove the screws that secure the system fan to the computer.
  - c. Push the system fan inwards and remove it from the computer.

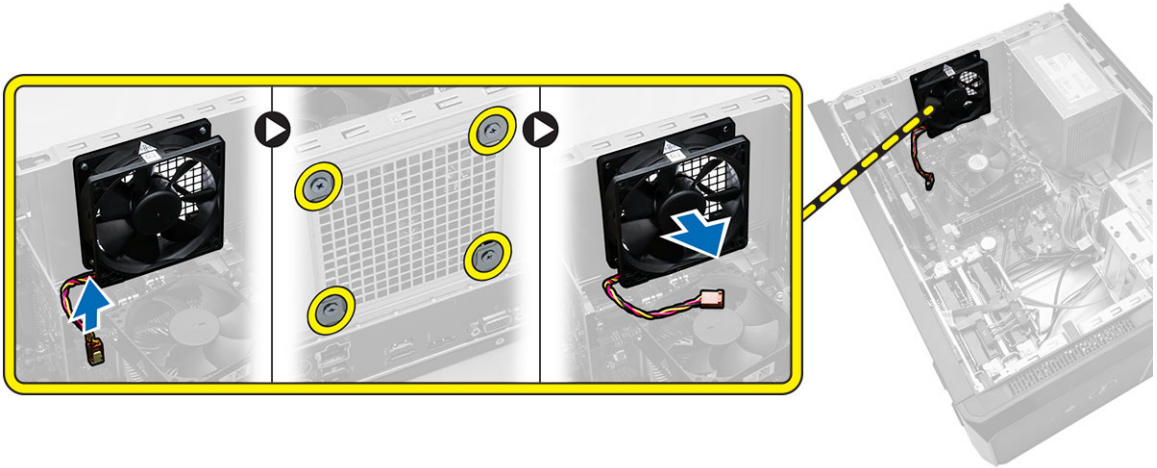

## Installing the System Fan

1. Place the fan on the computer.
2. Replace the screws to secure the fan to the computer.
3. Connect the fan cable to the system board.
4. Install the cover.
5. Follow the procedures in *After Working Inside Your Computer*.

## Removing the System Board

1. Follow the procedures in *Before Working Inside Your Computer*.
2. Remove the:
  - cover
  - bezel
  - optical drive
  - hard drive
  - heatsink
  - processor
  - memory
  - expansion cards

- I/O panel
3. Follow the steps to remove the system board:
    - a. Disconnect and un-thread all the cables connected to the system board.
    - b. Remove the screws that secure the system board to the computer.
    - c. Slide the system board towards the front of the computer and tilt to a 45-degree angle.
    - d. Lift and remove the system board out of the computer.

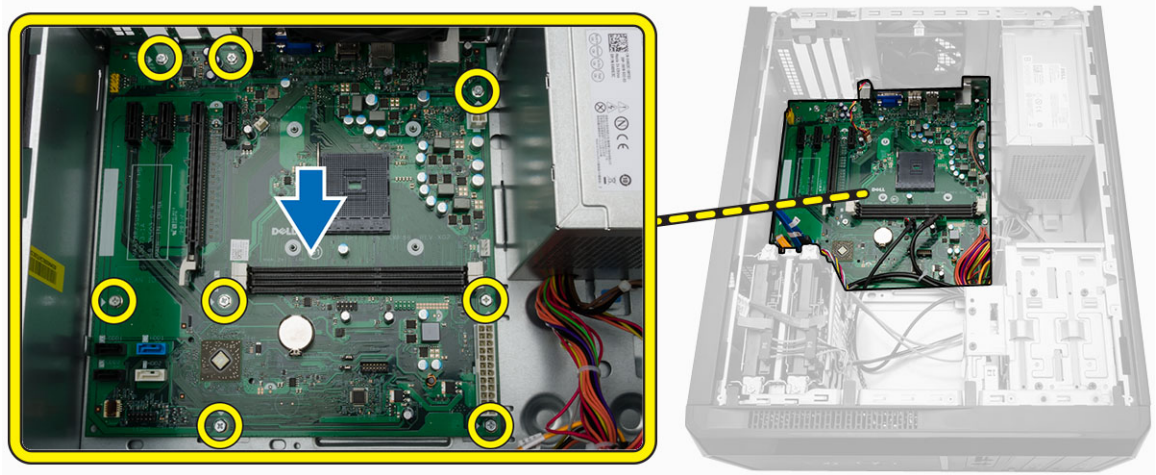

## Installing the System Board

1. Place the system board into the computer at a 45-degree angle and then slide it towards the back of the computer.
2. Replace the screws to secure the system board to the computer.
3. Thread and connect all the cables to the system board.
4. Install the:
  - I/O panel
  - memory
  - expansion cards
  - processor
  - heatsink
  - hard drive
  - optical drive
  - bezel
  - cover
5. Follow the procedures in After Working Inside Your Computer.

## System Board Components

The following image displays the system board components:

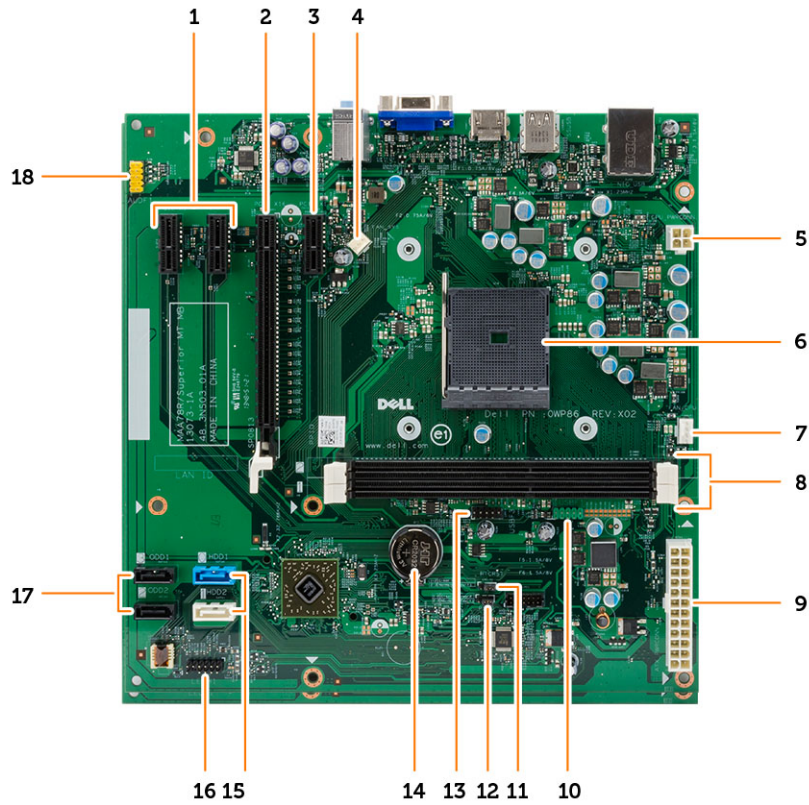

- |                                  |                           |
|----------------------------------|---------------------------|
| 1. PCIe x1 connector             | 2. PCIe x16 connector     |
| 3. PCIe x1 connector             | 4. system fan connector   |
| 5. P2 power connector            | 6. processor socket       |
| 7. CPU fan connector             | 8. memory connectors      |
| 9. P1 power connector            | 10. front USB connector   |
| 11. real-time clock reset jumper | 12. password reset jumper |
| 13. card reader connector        | 14. coin-cell battery     |
| 15. SATA connectors              | 16. front LED connector   |
| 17. SATA connectors              | 18. front audio connector |

# Troubleshooting Your Computer

You can troubleshoot your computer using indicators like Diagnostic Lights, Beep Codes, and Error Messages during the operation of the computer.

## Diagnostic Power LED Codes

Power LED Light Status	Possible Cause	Troubleshooting Steps
Off	The computer is either turned off or is not receiving power or in Hibernation mode.	<ul style="list-style-type: none"> <li>• Re-seat the power cable in the power connector on the back of the computer and the electrical outlet.</li> <li>• If the computer is plugged into a power strip, ensure the power strip is plugged into an electrical outlet and is turned on. Also, bypass power protection devices, power strips, and power extension cables to verify the computer turns on properly.</li> <li>• Ensure the electrical outlet is working by testing it with another device, such as a lamp.</li> </ul>
Steady / Blinking Amber	Computer fails to complete POST or processor failure.	<ul style="list-style-type: none"> <li>• Remove and then reinstall any cards.</li> <li>• Remove and then reinstall the graphics card, if applicable.</li> <li>• Ensure the power cable is connected to the motherboard and processor.</li> </ul>
Blinking White Light	Computer is in sleep mode.	<ul style="list-style-type: none"> <li>• Press the power button to bring the computer out of the sleep mode.</li> <li>• Ensure all power cables are securely connected to the system board.</li> <li>• Ensure the main power cable and front panel cable are securely connected to the system board.</li> </ul>
Steady White	The computer is fully functional and in the On state.	<p>If the computer is not responding, do the following:</p> <ul style="list-style-type: none"> <li>• Ensure the display is connected and turned on.</li> </ul>

Power LED Light Status	Possible Cause	Troubleshooting Steps
		<ul style="list-style-type: none"> <li>If the display is connected and turned on, listen for a beep code.</li> </ul>

## Diagnostic Error Messages

Error Messages	Description
AUXILIARY DEVICE FAILURE	The touchpad or external mouse may be faulty. For an external mouse, check the cable connection. Enable the <b>Pointing Device</b> option in the system setup program.
BAD COMMAND OR FILE NAME	Ensure that you have spelled the command correctly, put spaces in the proper place, and used the correct pathname.
CACHE DISABLED DUE TO FAILURE	The primary cache internal to the microprocessor has failed. <a href="#">Contact Dell</a> .
CD DRIVE CONTROLLER FAILURE	The optical drive does not respond to commands from the computer.
DATA ERROR	The hard drive cannot read the data.
DECREASING AVAILABLE MEMORY	One or more memory modules may be faulty or improperly seated. Reinstall the memory modules or, if necessary, replace them.
DISK C: FAILED INITIALIZATION	The hard drive failed initialization. Run the hard drive tests in the Dell Diagnostics.
DRIVE NOT READY	The operation requires a hard drive in the bay before it can continue. Install a hard drive in the hard drive bay.
ERROR READING PCMCIA CARD	The computer cannot identify the ExpressCard. Reinsert the card or try another card.
EXTENDED MEMORY SIZE HAS CHANGED	The amount of memory recorded in non-volatile memory (NVRAM) does not match the memory installed in the computer. Restart the computer. If the error appears again, <a href="#">contact Dell</a> .
THE FILE BEING COPIED IS TOO LARGE FOR THE DESTINATION DRIVE	The file that you are trying to copy is too large to fit on the disk, or the disk is full. Try copying the file to a different disk or use a larger capacity disk.
A FILENAME CANNOT CONTAIN ANY OF THE FOLLOWING CHARACTERS: \ / : * ? " < >   -	Do not use these characters in filenames.
GATE A20 FAILURE	A memory module may be loose. Reinstall the memory modules or, if necessary, replace them.

Error Messages	Description
GENERAL FAILURE	The operating system is unable to carry out the command. The message is usually followed by specific information. For example, Printer out of paper. Take the appropriate action.
HARD-DISK DRIVE CONFIGURATION ERROR	The computer cannot identify the drive type. Shut down the computer, remove the hard drive, and boot the computer from an optical drive. Then, shut down the computer, reinstall the hard drive, and restart the computer. Run the Hard Disk Drive tests in the Dell Diagnostics.
HARD-DISK DRIVE CONTROLLER FAILURE 0	The hard drive does not respond to commands from the computer. Shut down the computer, remove the hard drive, and boot the computer from an optical drive. Then, shut down the computer, reinstall the hard drive, and restart the computer. If the problem persists, try another drive. Run the Hard Disk Drive tests in the Dell Diagnostics.
HARD-DISK DRIVE FAILURE	The hard drive does not respond to commands from the computer. Shut down the computer, remove the hard drive, and boot the computer from an optical drive. Then, shut down the computer, reinstall the hard drive, and restart the computer. If the problem persists, try another drive. Run the <b>Hard Disk Drive</b> tests in the <b>Dell Diagnostics</b> .
HARD-DISK DRIVE READ FAILURE	The hard drive may be defective. Shut down the computer, remove the hard drive, and boot the computer from an optical. Then, shut down the computer, reinstall the hard drive, and restart the computer. If the problem persists, try another drive. Run the <b>Hard Disk Drive</b> tests in the Dell Diagnostics.
INSERT BOOTABLE MEDIA	The operating system is trying to boot to non-bootable media, such as a floppy disk or optical drive. Insert bootable media.
INVALID CONFIGURATION INFORMATION-PLEASE RUN SYSTEM SETUP PROGRAM	The system configuration information does not match the hardware configuration. The message is most likely to occur after a memory module is installed. Correct the appropriate options in the system setup program.
KEYBOARD CLOCK LINE FAILURE	For external keyboards, check the cable connection. Run the <b>Keyboard Controller</b> test in the <b>Dell Diagnostics</b> .

Error Messages	Description
KEYBOARD CONTROLLER FAILURE	For external keyboards, check the cable connection. Restart the computer, and avoid touching the keyboard or the mouse during the boot routine. Run the <b>Keyboard Controller</b> test in the <b>Dell Diagnostics</b> .
KEYBOARD DATA LINE FAILURE	For external keyboards, check the cable connection. Run the <b>Keyboard Controller</b> test in the <b>Dell Diagnostics</b> .
KEYBOARD STUCK KEY FAILURE	For external keyboards or keypads, check the cable connection. Restart the computer, and avoid touching the keyboard or keys during the boot routine. Run the <b>Stuck Key</b> test in the <b>Dell Diagnostics</b> .
LICENSED CONTENT IS NOT ACCESSIBLE IN MEDIADIRECT	Dell MediaDirect cannot verify the Digital Rights Management (DRM) restrictions on the file, so the file cannot be played.
MEMORY ADDRESS LINE FAILURE AT ADDRESS, READ VALUE EXPECTING VALUE	A memory module may be faulty or improperly seated. Reinstall the memory modules or, if necessary, replace them.
MEMORY ALLOCATION ERROR	The software you are attempting to run is conflicting with the operating system, another program, or a utility. Shut down the computer, wait 30 seconds, and then restart it. Try to run the program again. If the error message still appears, see the software documentation.
MEMORY DOUBLE WORD LOGIC FAILURE AT ADDRESS, READ VALUE EXPECTING VALUE	A memory module may be faulty or improperly seated. Reinstall the memory modules or, if necessary, replace them.
MEMORY ODD/EVEN LOGIC FAILURE AT ADDRESS, READ VALUE EXPECTING VALUE	A memory module may be faulty or improperly seated. Reinstall the memory modules or, if necessary, replace them.
MEMORY WRITE/READ FAILURE AT ADDRESS, READ VALUE EXPECTING VALUE	A memory module may be faulty or improperly seated. Reinstall the memory modules or, if necessary, replace them.
NO BOOT DEVICE AVAILABLE	The computer cannot find the hard drive. If the hard drive is your boot device, ensure that the drive is installed, properly seated, and partitioned as a boot device.
NO BOOT SECTOR ON HARD DRIVE	The operating system may be corrupted, <a href="#">contact Dell</a> .
NO TIMER TICK INTERRUPT	A chip on the system board may be malfunctioning. Run the <b>System Set</b> tests in the <b>Dell Diagnostics</b> .

Error Messages	Description
NOT ENOUGH MEMORY OR RESOURCES. EXIT SOME PROGRAMS AND TRY AGAIN	You have too many programs open. Close all windows and open the program that you want to use.
OPERATING SYSTEM NOT FOUND	Reinstall the hard drive. If the problem persists, <a href="#">contact Dell</a> .
OPTIONAL ROM BAD CHECKSUM SECTOR NOT FOUND	The optional ROM has failed. <a href="#">Contact Dell</a> . The operating system cannot locate a sector on the hard drive. You may have a defective sector or corrupted FAT on the hard drive. Run the Windows error-checking utility to check the file structure on the hard drive. See Windows Help and Support for instructions (click Start > Help and Support). If a large number of sectors are defective, back up the data (if possible), and then reformat the hard drive.
SEEK ERROR	The operating system cannot find a specific track on the hard drive.
SHUTDOWN FAILURE	A chip on the system board may be malfunctioning. Run the <b>System Set</b> tests in the <a href="#">contact Dell</a> .
TIME-OF-DAY CLOCK LOST POWER	System configuration settings are corrupted. Connect your computer to an electrical outlet to charge the battery. If the problem persists, try to restore the data by entering the system setup program, then immediately exit the program. If the message reappears, <a href="#">contact Dell</a> .
TIME-OF-DAY CLOCK STOPPED	The reserve battery that supports the system configuration settings may require recharging. Connect your computer to an electrical outlet to charge the battery. If the problem persists, <a href="#">contact Dell</a> .
TIME-OF-DAY NOT SET-PLEASE RUN THE SYSTEM SETUP PROGRAM	The time or date stored in the system setup program does not match the system clock. Correct the settings for the <b>Date and Time</b> options.
TIMER CHIP COUNTER 2 FAILED	A chip on the system board may be malfunctioning. Run the <b>System Set tests</b> in the <b>Dell Diagnostics</b> .
UNEXPECTED INTERRUPT IN PROTECTED MODE	The keyboard controller may be malfunctioning, or a memory module may be loose. Run the <b>System Memory</b> tests and the <b>Keyboard Controller</b> test in the <a href="#">System Setup</a> or <a href="#">contact Dell</a> .
X:\ IS NOT ACCESSIBLE. THE DEVICE IS NOT READY	Insert a disk into the drive and try again.

## System Error Messages

System Message	Description
Alert! Previous attempts at booting this system have failed at checkpoint [nnnn]. For help in resolving this problem, please note this checkpoint and contact Dell Technical Support	The computer failed to complete the boot routine three consecutive times for the same error.
CMOS checksum error	RTC is reset, BIOS Setup default has been loaded.
CPU fan failure	CPU fan has failed
System fan failure	System fan has failed
Hard-disk drive failure	Possible hard disk drive failure during POST
Keyboard failure	Keyboard failure or loose cable. If reseating the cable does not solve the problem, replace the keyboard.
No boot device available	<p>No bootable partition on hard disk drive, the hard disk drive cable is loose, or no bootable device exists.</p> <ul style="list-style-type: none"><li>• If the hard drive is your boot device, ensure that the cables are connected and that the drive is installed properly and partitioned as a boot device.</li><li>• Enter system setup and ensure that the boot sequence information is correct.</li></ul>
No timer tick interrupt	A chip on the system board might be malfunctioning or motherboard failure.
NOTICE - Hard Drive SELF MONITORING SYSTEM has reported that a parameter has exceeded its normal operating range. Dell recommends that you back up your data regularly. A parameter out of range may or may not indicate a potential hard drive problem	S.M.A.R.T error, possible hard disk drive failure.

# System Setup Options

## Main

---

<b>System Information</b>	
BIOS Revision	Displays the BIOS revision.
BIOS Build Date	Displays the date the system BIOS was built.
System Name	Displays the model name of the system.
System Time	Resets the time on the computer's internal clock.
System Date	Resets the date on the computer's internal calendar.
Service Tag	Displays the service tag of your computer.
Asset Tag	Displays the asset tag of your computer (if available).
<b>Processor Information</b>	
Processor Type	Displays the type of processor.
Processor ID	Displays the processor ID.
Processor Core Count	Displays the processor core count.
Processor L1 Cache	Displays the processor L1 cache size.
Processor L2 Cache	Displays the processor L2 cache size.
<b>Memory Information</b>	
Memory Installed	Displays the total computer memory.
Memory Available	Displays the available memory.
Memory Running Speed	Displays the memory speed.
Memory Technology	Displays the memory type and technology.
<b>SATA Information</b>	
SATA 0	Displays the model number and capacity of the hard drive.
SATA 1	Displays the model number and capacity of the hard drive.
SATA 2	Displays the model number and capacity of the hard drive.
SATA 3	Displays the model number and capacity of the hard drive.

# Advanced

---

## Processor Configuration

---

AMD Cool 'N' Quiet	Allows you to enable or disable the AMD Cool 'N' Quiet mode in the installed processor in the system.	Default: Enabled
Secure Virtual Machine Mode	Allows you to enable or disable AMD Secure Virtual Machine Mode (SVM).	Default: Enabled

## USB Configuration

Front USB Ports	Allows you to enable or disable the Front USB Ports.	Default: Enabled
Rear USB Ports	Allows you to enable or disable the Rear USB Ports.	Default: Enabled

## Onboard Device Configuration

Onboard Audio Controller	Allows you to enable or disable the onboard audio controller.	Default: Enabled
SATA Mode	Displays the SATA Mode	Default: AHCI
Onboard LAN Controller	Allows you to enable or disable the onboard LAN controller.	Default: Enabled
Onboard LAN Boot ROM	Allows you to enable or disable the onboard LAN boot ROM.	Default: Disabled

# Boot

Numlock Key	Allows you to enable or disable the numlock key during Boot.
Secure Boot Control	Allows you to enable or disable the Secure Boot Control.
Secure Boot Mode	Allows you to select the secure boot mode selector.
Load Legacy OPROM	Allows you to enable or disable loading of a legacy OPROM.
Keyboard Errors	Allows you to enable or disable the displaying keyboard errors.
USB Boot Support	Allows you to enable or disable USB Boot Support.
Boot Mode	Allows you to select the boot mode.
1st Boot Device	Allows you to enable or disable the boot device.
2nd Boot Device	Allows you to enable or disable the boot device.
3rd Boot Device	Allows you to enable or disable the boot device.

4th Boot Device	Allows you to enable or disable the boot device.
5th Boot Device	Allows you to enable or disable the boot device.
Hard Disk Drivers	Displays information about hard-disk drivers.
CD/DVD ROM Drivers	Displays information about CD/DVD ROM drivers.
Network Drivers	Displays information about network drives.

## Power

Wake up by Integrated LAN/WLAN	Allows you to enable or disable Wake up by Integrated LAN/WLAN
AC Recovery	Specifies the AC recovery mode.
Auto Power On	Allows you to enable or disable Auto Power On mode.
Auto Power On Mode	Allows you to select the day to enable the Auto Power On mode.
Auto Power On Date	Allows you to select the specific date to enable the Auto Power On mode.
Auto Power On Time	Allows you to select the specific time to enable the Auto Power On mode.

## Security

Supervisor Password	Specifies whether an administrator password has been assigned.
User Password	Specifies whether a user password has been assigned.
Set Supervisor Password	Allows you to change or delete the administrator password.
HDD Protection	Allows you to enable or disable the HDD protection.

## Exit

This section allows you to save, discard, and load default settings before exiting from System Setup.

## System Setup Overview

System Setup allows you to:

- change the system configuration information after you add, change, or remove any hardware in your computer.
- set or change a user-selectable option such as the user password.
- read the current amount of memory or set the type of hard drive installed.

Before you use System Setup, it is recommended that you write down the System Setup screen information for future reference.

 **CAUTION: Unless you are an expert computer user, do not change the settings for this program. Certain changes can cause your computer to work incorrectly.**

## Enter System Setup

1. Turn on (or restart) your computer.
2. After the white Dell logo appears, press <F2> or <F12> immediately.

The System Setup page displays.

 **NOTE:** If you wait too long and the operating system logo appears, continue to wait until you see the desktop. Then, shut down or restart your computer and try again.

# Specifications

 **NOTE:** Offerings may vary by region. The following specifications are only those required by law to ship with your computer. For more information about the configuration of your computer, go to **Help and Support** in your Windows operating system and select the option to view information about your computer.

<b>Processor</b>	
Type	<ul style="list-style-type: none"> <li>• AMD Sempron 250</li> <li>• AMD Athlon X2 350</li> <li>• AMD A4-6300</li> <li>• AMD A6-6400K</li> <li>• AMD A8-6500</li> </ul>
L2 cache	Up to 4 MB
<b>Memory</b>	
Memory module connector	two DIMM slots
Memory module capacity	2 GB, 4 GB, and 8 GB
Type	1600 MHz DDR3 (Non-ECC)
Minimum memory	2 GB
Maximum memory	16 GB
<b>Video</b>	
Video Type:	
Integrated	AMD Radeon
Discrete	<ul style="list-style-type: none"> <li>• AMD HD 8490 (1 GB DDR3) DP/DVI (UI)</li> <li>• NVIDIA GeForce GT 705 1 GB GDDR3</li> </ul>
Integrated video memory	Shared system memory
<b>Audio</b>	
Integrated	Integrated 5.1 high-definition audio
<b>Network</b>	
Integrated	Realtek 10/100/1000 Mbps Ethernet

---

**System Information**

---

Chipset	AMD A78
BIOS chip (NVRAM)	4 MB SPI Flash ROM

---

**Expansion Bus**

---

Bus speed:	
PCI Express	PCIe 2.0 at speeds upto 5.0 GT/s
SATA	SATA Gen 3 at 6 Gb/s
USB speed:	
USB 2.0	480 Mb/s
USB 3.0	5 Gb/s

---

**Cards**

---

PCIe x16	one full-height card
PCIe x1	up to three full-height cards

---

**Drives**

---

Externally accessible:	
5.25-inch drive bays	one
Internally accessible:	
3.5-inch drive bays	one

---

**External Connectors**

---

Audio:	
Back panel	three connectors
Front Panel	two front-panel connectors for headphone and microphone
Network	one RJ45 connector
USB:	
Front panel	two USB 2.0 connectors
Back panel	<ul style="list-style-type: none"><li>• two USB 2.0 connectors</li><li>• two USB 3.0 connectors</li></ul>
Video	<ul style="list-style-type: none"><li>• one 15-hole VGA connector</li><li>• one 19-pin HDMI connector</li></ul>

---

**Control Lights And Diagnostic Lights**

---

power button light	white light — solid white light indicates power-on state.  blinking white light — solid white light indicates sleep state of the computer; steady / blinking amber light indicates a problem with the system board.
drive activity light	white light — blinking white light indicates that the computer is reading data from, or writing data to the hard drive.

---

**Power**

---

Coin-cell battery	3 V CR2032 lithium coin cell
Input voltage	180 VAC–264 VAC
Input frequency	50 Hz to 60 Hz
Wattage	200 W
Input current	3.0 A

 **NOTE:** Total power output of +5 V and +3.30 V can not exceed 80 W.

Maximum heat dissipation	682 BTU/hr
--------------------------	------------

 **NOTE:** Heat dissipation is calculated by using the power supply wattage rating.

---

**Physical**

---

Height	360 mm (14.17 inches)
Width	175 mm (6.88 inches)
Depth	436.3 mm (17.17 inches)
Weight (Minimum)	8.60 kg (18.96 lb)

---

**Environmental**

---

Temperature:

Operating 10 °C to 35 °C (50 °F to 95 °F)

Storage –40 °C to 65 °C (–40 °F to 149 °F)

Relative humidity 20 % to 80 % (non-condensing)

Altitude:

Operating –15.20 m to 5000 m (–50 ft to 10,000 ft)

Storage –15.20 m to 5000 m (–50 ft to 35,000 ft)

Airborne contaminant level G1 as defined by ISA-S71.04–1985

# Contacting Dell

 **NOTE:** If you do not have an active Internet connection, you can find contact information on your purchase invoice, packing slip, bill, or Dell product catalog.

Dell provides several online and telephone-based support and service options. Availability varies by country and product, and some services may not be available in your area. To contact Dell for sales, technical support, or customer service issues:

1. Visit **dell.com/support**
2. Select your support category.
3. Verify your country or region in the Choose a Country/Region drop-down menu at the top of page.
4. Select the appropriate service or support link based on your need.